



Wall Mounted Foam Unit

For pre-mix products

Thin layer of foam coverage to minimize product consumption

Polypropylene trigger handle with 65° fan tip for increased coverage

25 ft. (7.6 m) coiled twin-line tubing for convenient use

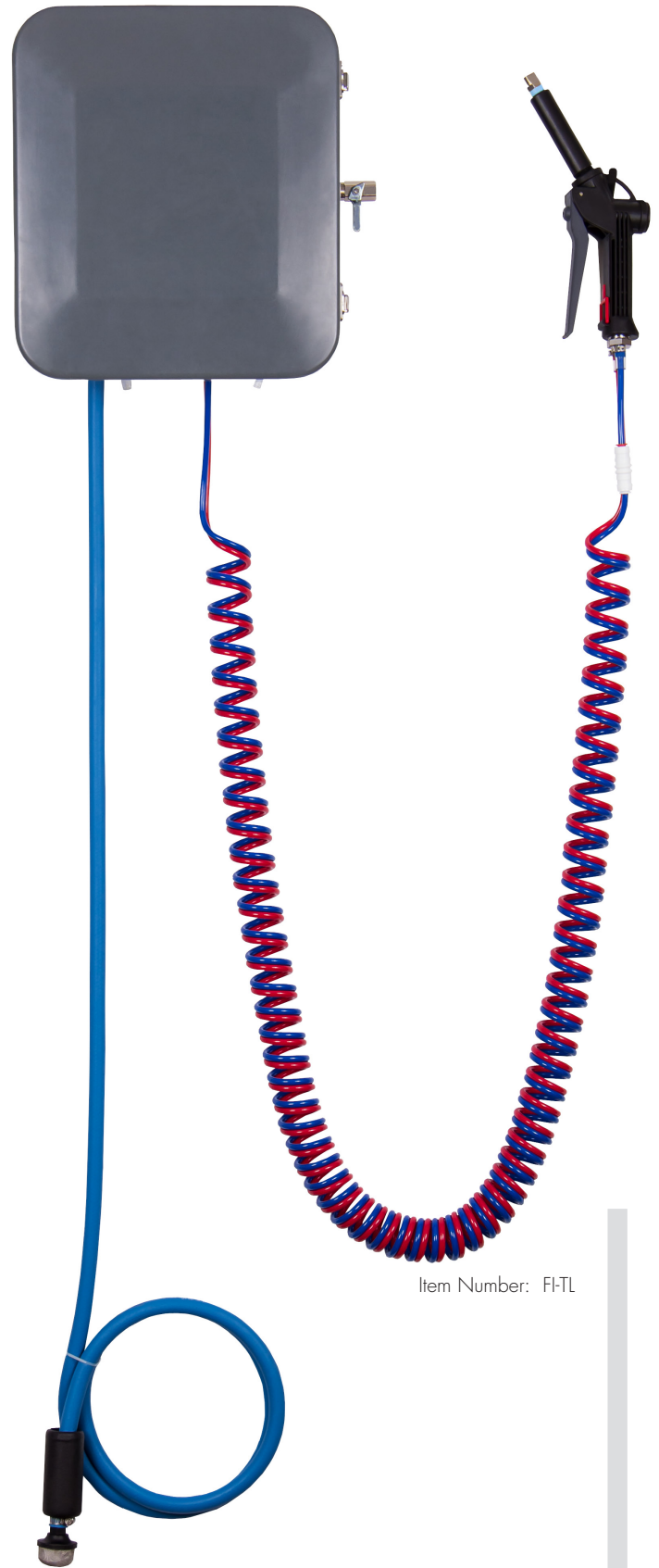
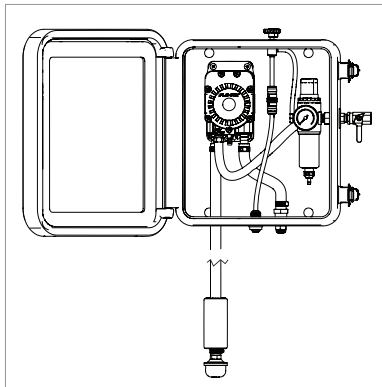
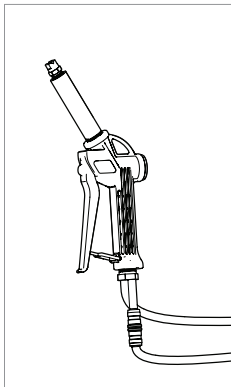

Item Number: FI-TL